

BLÄNKKA 90

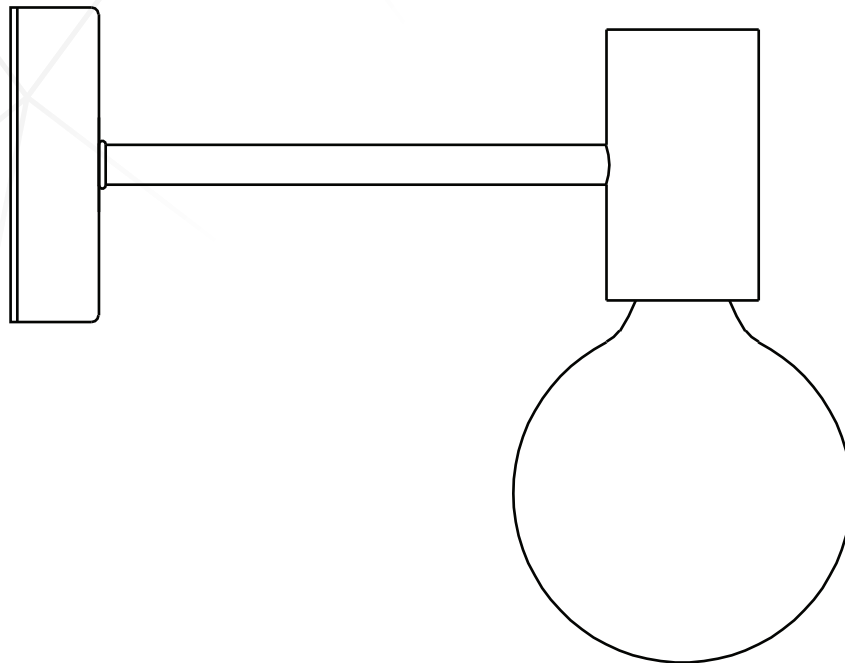

bathlife®

OF SWEDEN



Copyright ©2020 Bygghemma Sverige AB. Original content rights reserved. All product names, logos, and brands are property of their respective owners.



Information contained within this document was considered accurate at the time of publication, but may be subject to revision.

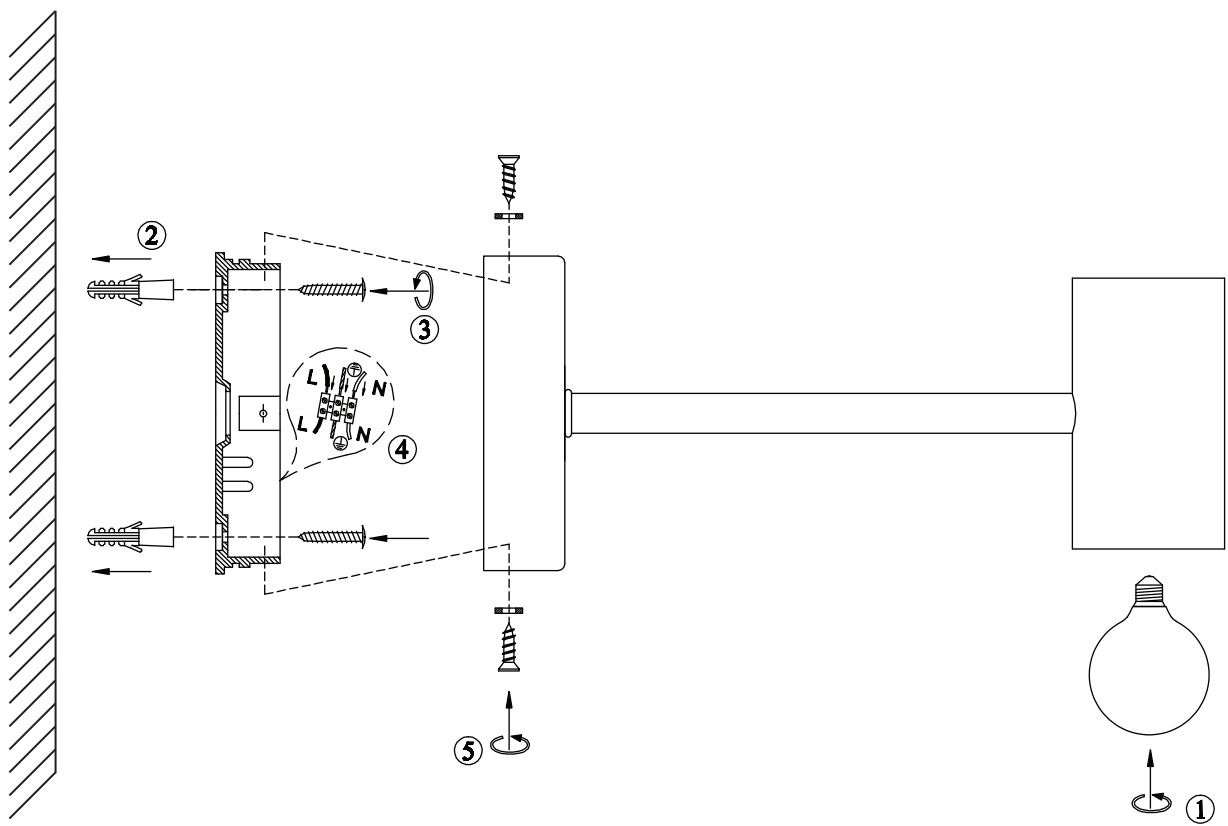

Copyright ©2020 Bygghemma Sverige AB. Original content rights reserved. All product names, logos, and brands are property of their respective owners.



Information contained within this document was considered accurate at the time of publication, but may be subject to revision.